

Profile

- Freely programmable electronic digital display for length or angular measurement
- Hollow shaft, max. \varnothing 30 mm
- LCD display with 5 digits and special characters
- Digit height approx. 12 mm
- Reset, incremental measurement, offset via keyboard
- Long battery life
- Easy battery change without dismantling of the device

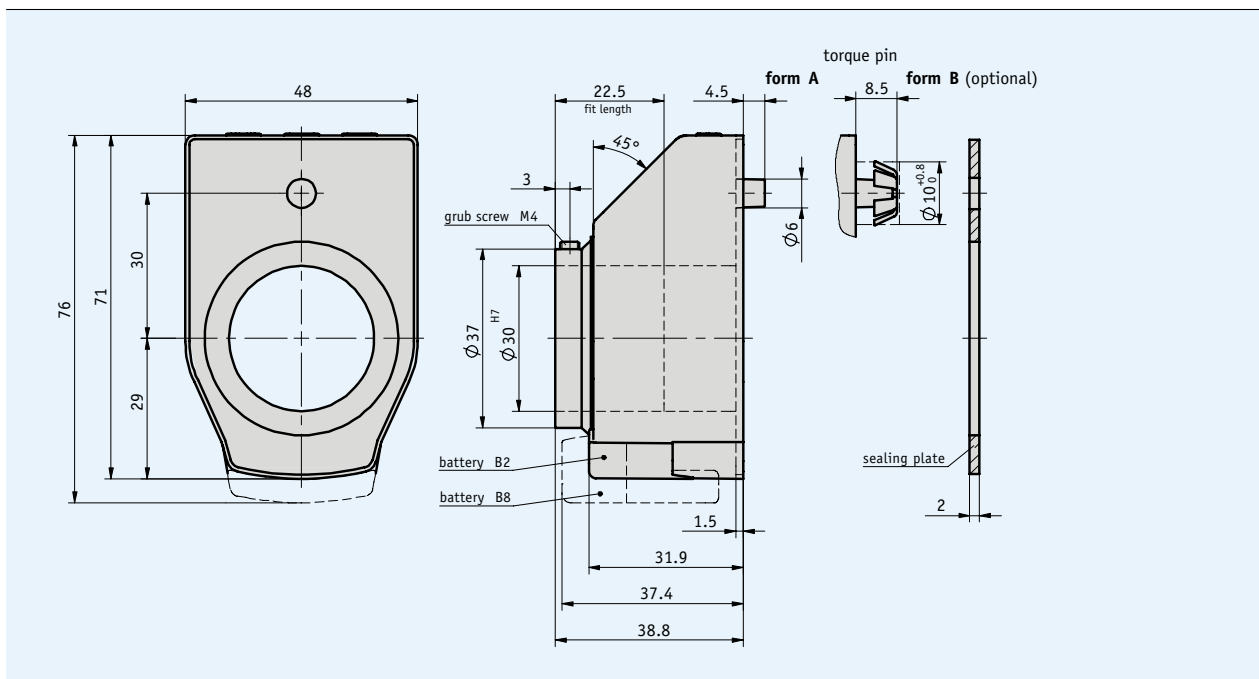

1.2

Mechanical data





Feature	Technical data	Additional information
Weight	approx. 0.1 kg	
Hollow shaft	\varnothing 30H7, plain bearing, browned steel	
Rotational speed	max. 600 rpm (100 % operation time)	
Protection category	IP51	
Operating temperature	-10 ... +60 °C	
Storage temperature	-30 ... +80 °C	
Housing	plastic	
Shock resistance	30 g / 15 ms	according to DIN EN 60068-2-27
Vibration resistance	10 g / (5 ... 150 Hz) 20 g / (100 ... 2.000 Hz)	according to DIN EN 60068-2-6 according to DIN EN 60068-2-6

Electrical data

Feature	Technical data	Additional information
Display	LCD display, 5-digit, 11.5 mm digit height	
Display range	-19999 ... 99999	
Battery	lithium coin cell, 3 V, CR2032 type	~2 years of service life
	lithium coin cell, 3 V, CR2477 type	~8 years of service life
EMC	DIN EN 61000-4-2	
	DIN EN 61000-4-4	

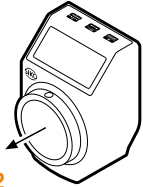
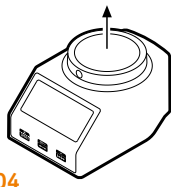
Order

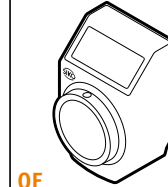
Order note

Mounting position		Key pad operation			Counting direction
 O2	 O4	 D/V	 K	 OF	

Note: Characters highlighted in orange are order features

1.2

Display
displayed value
not displayed

display divisor
measured value per revolution

Display divisor

The indication of the measured value on the display can be influenced by means of the divisor (divider). The divisor shifts figures of the measured value into the invisible sector of the display unit. Although the figures are not displayed, they are also calculated by the electronics unit and mathematically rounded.

Calculation of value displayed (example: order text):

Measured value per revolution 25324
Display divisor 1000

Feature	Value displayed	Measured value
1 st revolution	25	25324
2 nd revolution	51	50648
3 rd revolution	76	75972

